



**STAR CASE MFG. CO., INC.**

648 Superior Avenue  
 Munster, IN 46321  
 (219)922-4440 FAX: (219)922-4442  
 (800)822-STAR  
 (800)272-CASE  
 web: www.starcase.com  
 email: star@starcase.com

MANUFACTURER: \_\_\_\_\_  
 MODEL #: \_\_\_\_\_  
 DESCRIPTION: \_\_\_\_\_  
 \_\_\_\_\_  
 WEIGHT: \_\_\_\_\_  
 DOLLAR VALUE: \_\_\_\_\_  
 MEASURED AT: \_\_\_\_\_  
 ON: \_\_\_\_ / \_\_\_\_ / \_\_\_\_ BY: \_\_\_\_\_

# LCD/LED/PLASMA DISPLAY

What is the thickness of the screen 4" from edge?

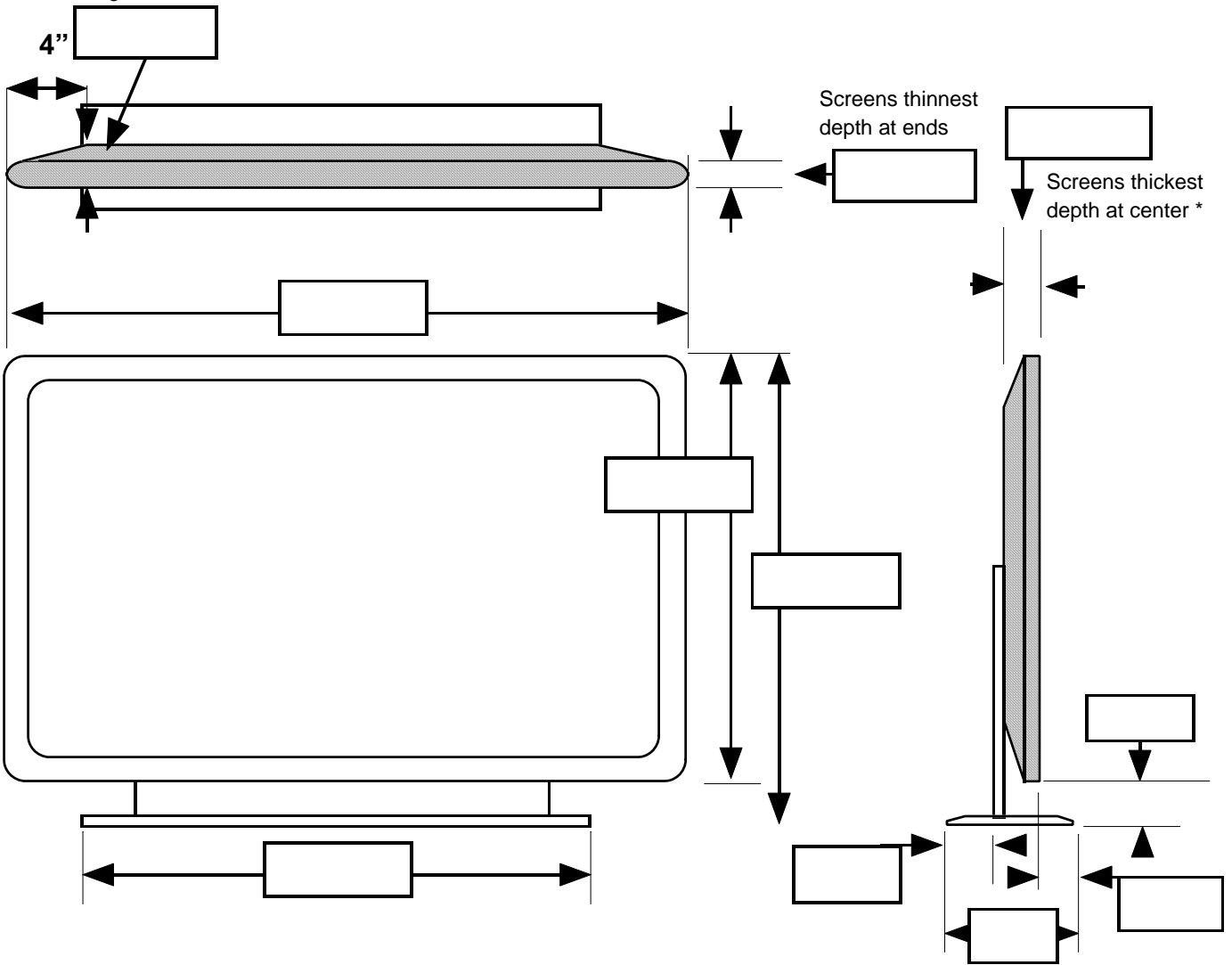

*Display with Wallmount*

Wall mount bracket - If display is so equipped, provide dimensions here.

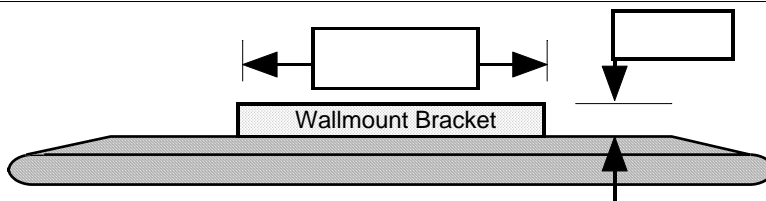

*STAR CASE  
 "EXHIBITOR"*

**STAR CASE MFG. CO., INC.**  
 648 Superior Avenue  
 Munster, IN 46321  
 (219)922-4440 FAX: (219)922-4442  
 (800)822-STAR  
 (800)782-CASE

FRONT VIEW-LID REMOVED-SHOWING CASE INTERIOR

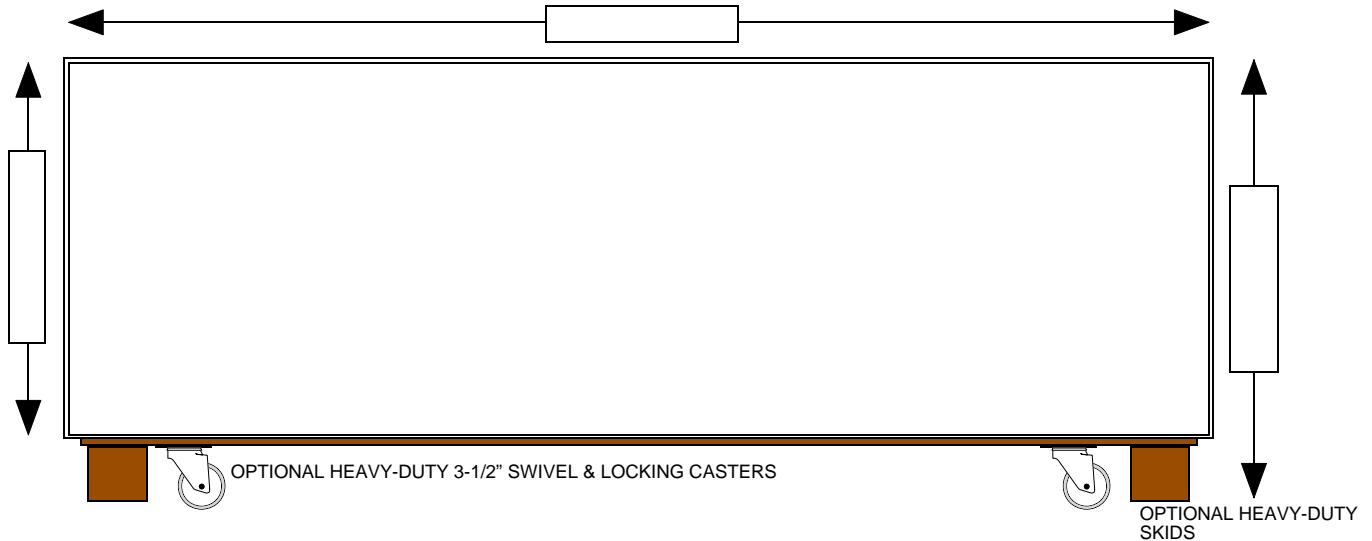

CASE FRONT REMOVABLE LID-REMOVED-SHOWING OPTIONAL COLLAPSIBLE TABLE LEGS

**MOST POPULAR OPTIONS TO CONSIDER:**

Table legs elevate lid to a 30" height table.

	Heavy duty table legs in case lid?	YES	<input type="checkbox"/>	NO	<input type="checkbox"/>
	Heavy duty swivel & locking casters?	YES	<input type="checkbox"/>	NO	<input type="checkbox"/>
	Protective skids on bottom of case?	YES	<input type="checkbox"/>	NO	<input type="checkbox"/>
	Interior partitioning? (show us above)	YES	<input type="checkbox"/>	NO	<input type="checkbox"/>

SIDE VIEW-CASE CLOSED

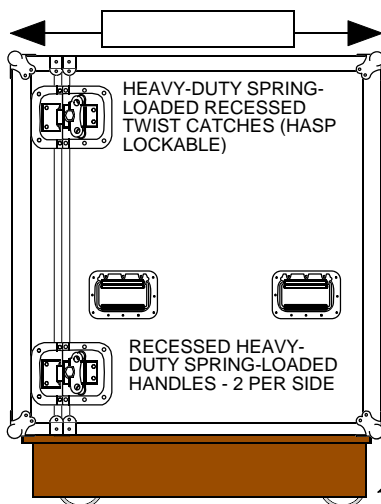

Note: Casters remain fully operational with skids installed.

**PROPRIETARY MATERIAL**

**DO NOT COPY, DUPLICATE OR REPRINT**

This drawing and the design depicted, remains the property of STAR CASE MANUFACTURING CO., INC. and may not be used for any purpose without the express written permission from STAR CASE MANUFACTURING CO., INC.

Exterior Color Choices



# LCD/LED FLAT PANEL DISPLAY



**STAR CASE MFG. CO., INC.**  
 648 Superior Avenue  
 Munster, IN 46321  
 (219)922-4440 FAX: (219)922-4442  
 (800)822-STAR  
 (800)272-CASE  
 web: [www.starcase.com](http://www.starcase.com)  
 email: [starcase@starcase.com](mailto:starcase@starcase.com)

**IMPORTANT!!**

Be sure that monitor is in 90 degree upright position and adjusted to lowest position prior to measuring!!

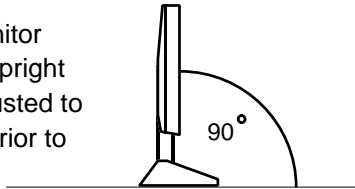

MANUFACTURER: \_\_\_\_\_  
 MODEL #: \_\_\_\_\_  
 DESCRIPTION: \_\_\_\_\_  
 display \_\_\_\_\_  
 WEIGHT: \_\_\_\_\_  
 DOLLAR VALUE: \_\_\_\_\_  
 MEASURED AT: \_\_\_\_\_  
 ON: \_\_\_\_ / \_\_\_\_ / \_\_\_\_ BY: \_\_\_\_\_

FRONT VIEW

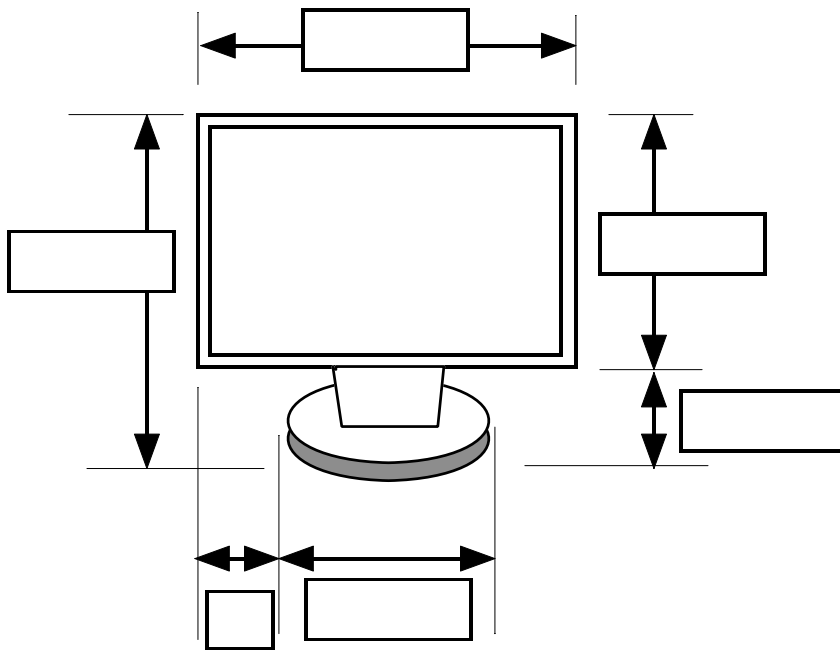

SIDE VIEW

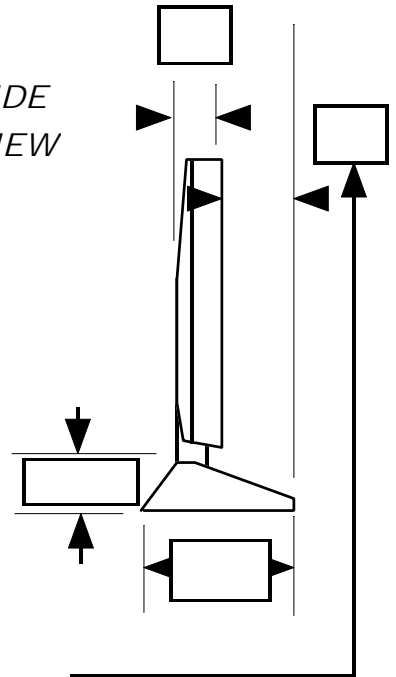

TOP VIEW

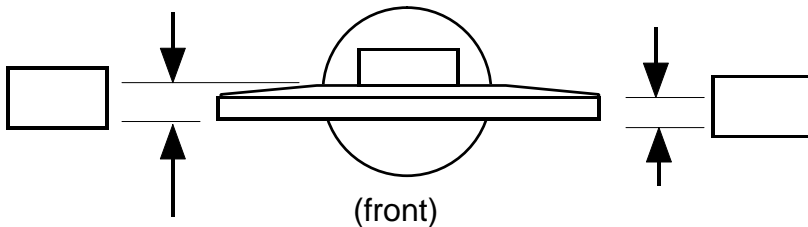

**IMPORTANT NOTE!!**  
 This dimension represents the distance the pedestal stand extends beyond the flat front surface of the LCD display.



**STAR CASE MFG. CO., INC.**

648 Superior Avenue  
 Munster, IN 46321  
 (219)922-4440 FAX: (219)922-4442  
 (800)822-STAR  
 (800)272-CASE  
 web: www.starcase.com  
 email: star@starcase.com

MANUFACTURER: \_\_\_\_\_  
 MODEL #: \_\_\_\_\_  
 DESCRIPTION: \_\_\_\_\_  
 \_\_\_\_\_  
 WEIGHT: \_\_\_\_\_  
 DOLLAR VALUE: \_\_\_\_\_  
 MEASURED AT: \_\_\_\_\_  
 ON: \_\_\_ / \_\_\_ / \_\_\_ BY: \_\_\_\_\_

# LAPTOP/NOTEBOOK COMPUTER

**NOTE!!**  
 Show any protruding knobs,  
 oversized battery packs, etc.  
 Specify if laptop is in a carrying bag  
 or not.

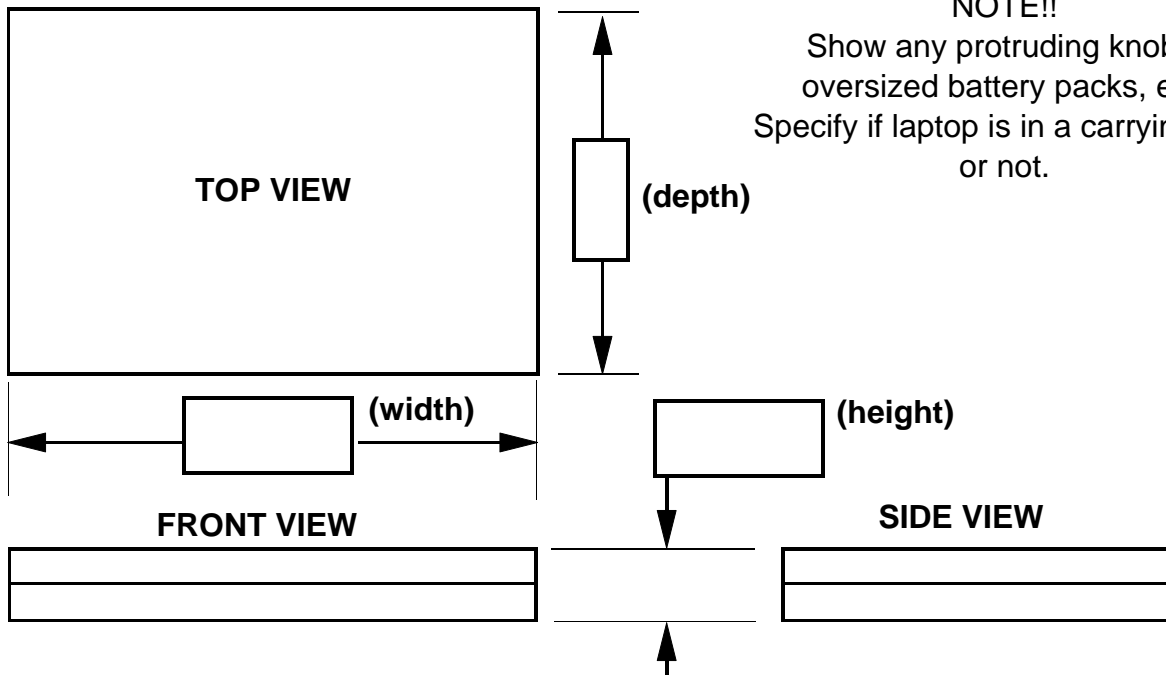

A/C adaptor

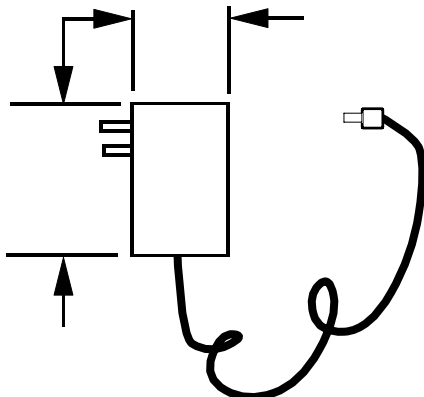

Any other items such as spare batteries, etc.



**STAR CASE MFG. CO., INC.**

648 Superior Avenue  
Munster, IN 46321  
(219)922-4440 FAX: (219)922-4442  
(800)822-STAR  
(800)272-CASE  
web: www.starcase.com  
email: star@starcase.com

MANUFACTURER: \_\_\_\_\_  
 MODEL #: \_\_\_\_\_  
 DESCRIPTION: \_\_\_\_\_  
 \_\_\_\_\_  
 WEIGHT: \_\_\_\_\_  
 DOLLAR VALUE: \_\_\_\_\_  
 MEASURED AT: \_\_\_\_\_  
 ON: \_\_\_\_ / \_\_\_\_ / \_\_\_\_ BY: \_\_\_\_\_

**UPRIGHT TOWER  
CPU & K'BD.**

**NOTE!!**

Show any protruding knobs,  
switches, cable connectors, fuse  
caps, etc.

TOP VIEW

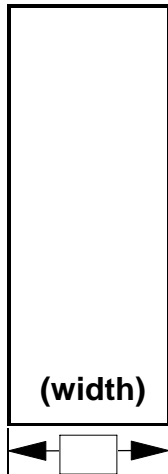
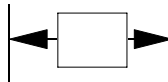
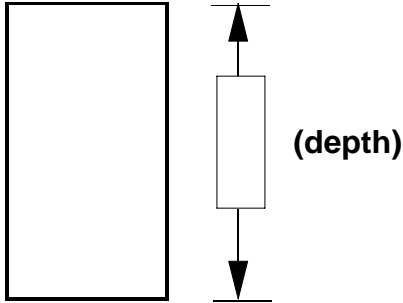

FRONT VIEW

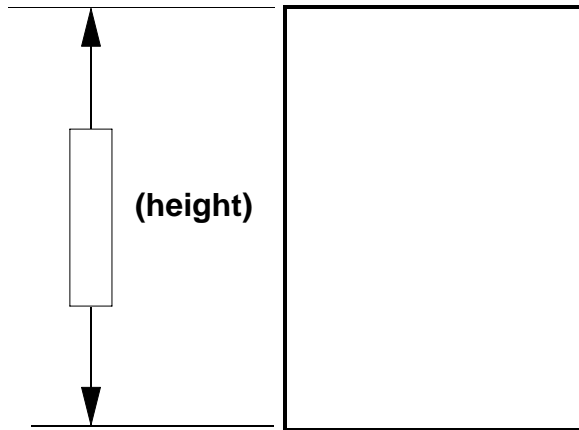

SIDE VIEW

TOP VIEW

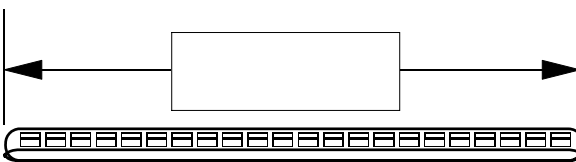
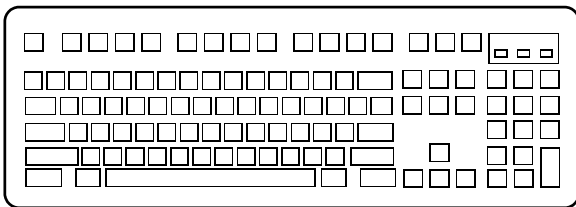

FRONT VIEW

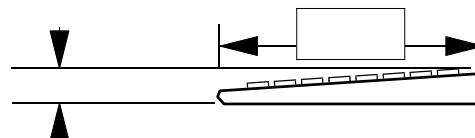

SIDE VIEW



**STAR CASE MFG. CO., INC.**

648 Superior Avenue  
 Munster, IN 46321  
 (219)922-4440 FAX: (219)922-4442  
 (800)822-STAR  
 (800)272-CASE  
 web: www.starcase.com  
 email: star@starcase.com

MANUFACTURER: \_\_\_\_\_  
 MODEL #: \_\_\_\_\_  
 DESCRIPTION: \_\_\_\_\_  
 \_\_\_\_\_  
 WEIGHT: \_\_\_\_\_  
 DOLLAR VALUE: \_\_\_\_\_  
 MEASURED AT: \_\_\_\_\_  
 ON: \_\_\_ / \_\_\_ / \_\_\_ BY: \_\_\_\_\_

**NOTE!!**  
 Show any protruding knobs, switches, heat sinks, fuse caps, etc. that extend of rear of device.

**MIXER/EDITOR**

TOP VIEW

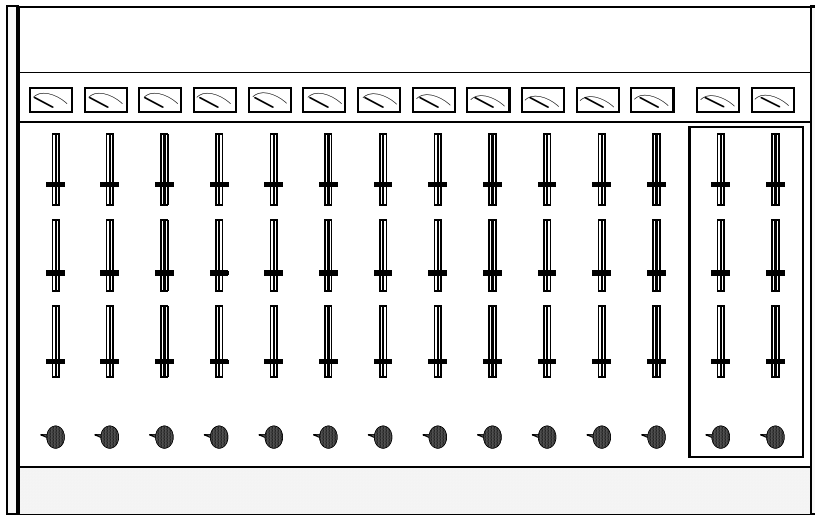

REAR VIEW

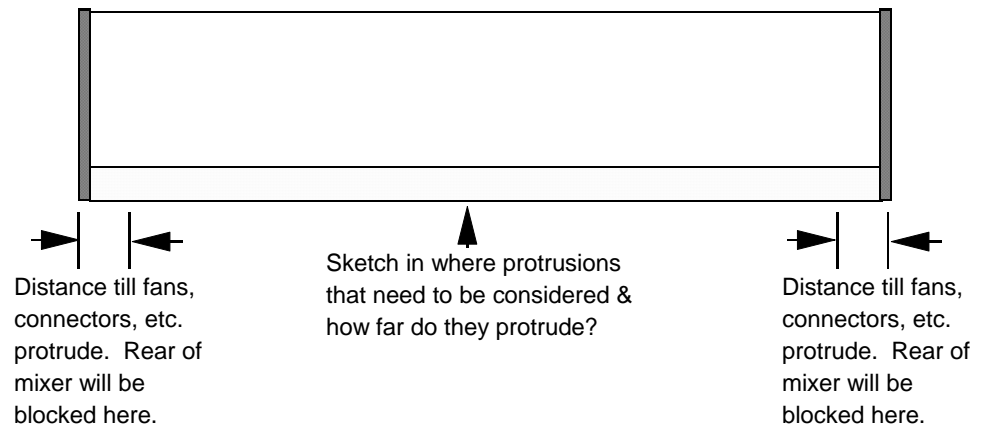

FRONT VIEW

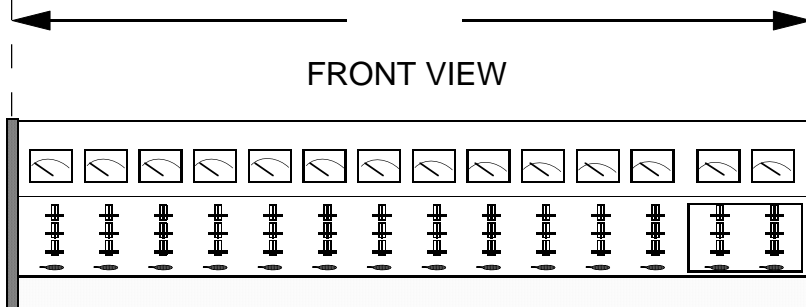

SIDE VIEW

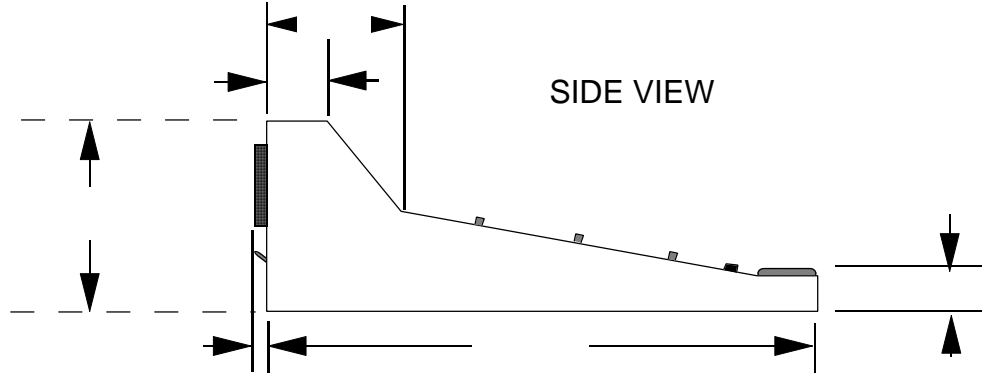



**STAR CASE MFG. CO., INC.**

648 Superior Avenue  
 Munster, IN 46321  
 (219)922-4440 FAX: (219)922-4442  
 (800)822-STAR  
 (800)272-CASE  
 web: www.starcase.com  
 email: star@starcase.com

MANUFACTURER: \_\_\_\_\_  
 MODEL #: \_\_\_\_\_  
 DESCRIPTION: \_\_\_\_\_  
 \_\_\_\_\_  
 WEIGHT: \_\_\_\_\_  
 DOLLAR VALUE: \_\_\_\_\_  
 MEASURED AT: \_\_\_\_\_  
 ON: \_\_\_\_ / \_\_\_\_ / \_\_\_\_ BY: \_\_\_\_\_

# LCD MULTIMEDIA PROJECTOR

**NOTE!!**

Show any protruding knobs, switches, heat syncs, fuse caps, etc.

