

# POPULAR CASE OPTIONS

## LOCKS

Recessed Twist/Combination Lock Assembly

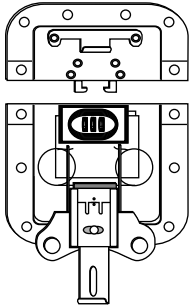

Recessed Twist/Key Lock Assembly

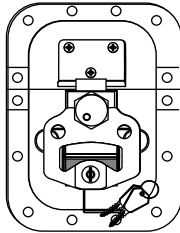

Recessed Twist/Hasp Lock Assembly

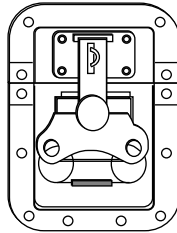

Plate Mounted Flush Key Lock Assembly

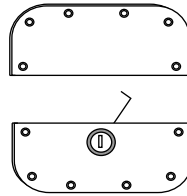
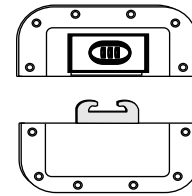

Plate Mounted Recessed Combination Lock Assembly



Remember, unless requested, locks are not standard issue with Star Cases. Locking options are available on nearly any STAR ATA grade case. Certain lock options might not conform to case dimensions requested. Case designs calling for removable lids will require a minimum of 2 locks per lid. Please call Star Case to confirm which lock options will work most effectively on your specific case design.

## CASTERS

Distance between floor and bottom of case with casters and casterboards installed.

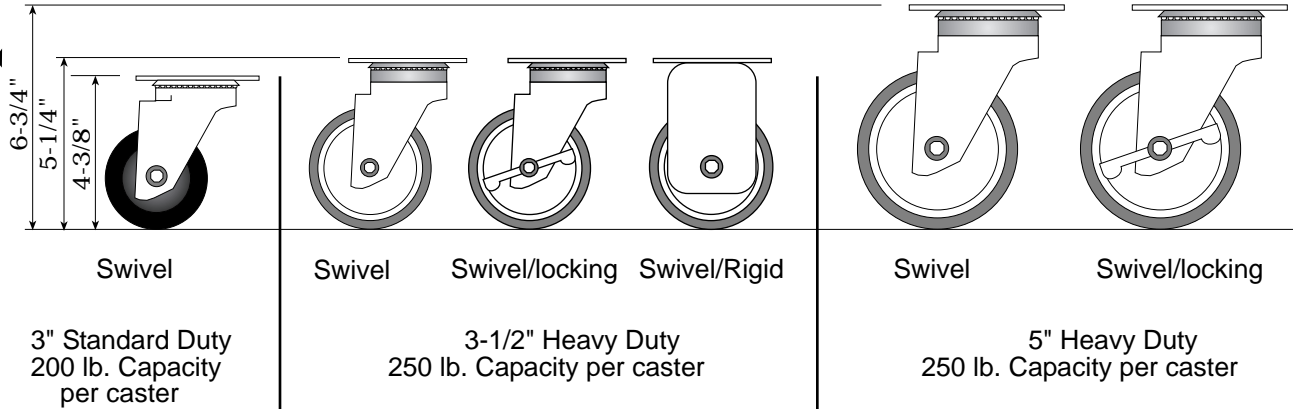

## CASE CART\*

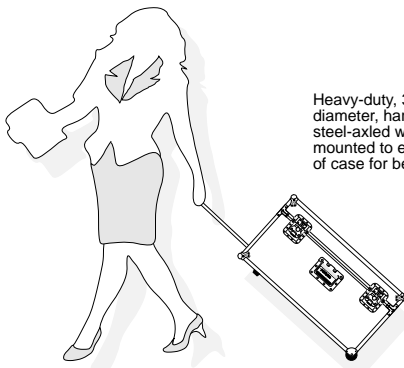

\* The Case Cart Option has certain limitations & size restrictions. Please call us before committing to this option.

Heavy-duty, 3" diameter, hard rubber, steel-axled wheels are mounted to extreme corners of case for best stability.

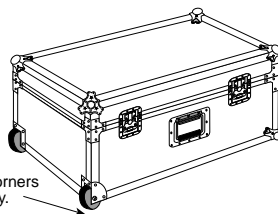

Case Cart option includes 2 heavy-duty 3" recessed casters & retractable, telescopic, aluminum tow handle

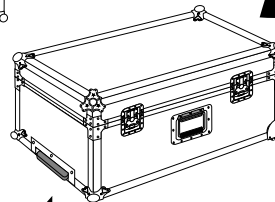

Heavy-duty, lock-in & out, telescoping aluminum, recessed, retractable tow handle

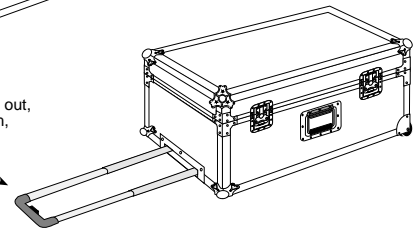

# NEW!!

## CORPORATE HEADQUARTERS

Star Case Manufacturing Co., Inc.  
 648 Superior - Munster, IN 46321  
 (219)922-4440 Fax: (219)922-4442  
 Outside Indiana (800)822-STAR  
 Inside Indiana (800)782-CASE  
 E-MAIL: [starcase@starcase.com](mailto:starcase@starcase.com)  
 WWW: <http://www.starcase.com>